

***AMPETRONIC***

**MLD9  
Installation Handbook**

[www.ampetronic.co](http://www.ampetronic.co)



## Handbook Contents

- Safety
- Introduction
- Quick start
- Installation
- Overview
- Troubleshooting
- Accessories
- Technical specifications
- Warranty
- Declaration of conformity

## Box Contents

- 1 x MLD9
- 2 x Loop connector
- 1 x Status connector
- 1 x DC connector
- 1 x Installation handbook
- 2 x 2mm steel 1U rack mount brackets
- 1 x Power cable (regions specific)
- 1 x Induction Loop Sign





**This symbol is used to alert the user to important operating or maintenance instructions.**



**The Lightning bolt triangle is used to alert the user to the risk of electric shock.**

## SAFETY

1. It is important to read these instructions, and to follow them.
2. Keep this instruction manual in an accessible place.
3. Clean only with a dry cloth. Cleaning fluids may effect the equipment.
4.  Do not block any ventilation openings. Install in accordance with the manufacturer's instructions.
5. Do not install this equipment near any heat sources such as radiators, heating vents or other apparatus that produces heat.
6.  **WARNING – THIS APPARATUS MUST BE EARTHED / GROUNDED.**
7. Only power cords with the correct power connector may be used to maintain safety. Cables incorporating the UK 13A fused plug, Schuko with earthing contacts and UL approved “grounding type” are acceptable. These must be plugged into power outlets which provide a protective earth.
8. Refer all servicing to qualified personnel. Servicing is required when the apparatus has been damaged in any way, such as a power supply cord or plug is damaged, liquid has been spilled or objects have fallen into the apparatus, the apparatus has been exposed to any rain or moisture, does not operate normally or has been dropped.
9.  **WARNING – To reduce the risk of fire or electric shock, do not expose this apparatus to rain or moisture. The apparatus shall not be exposed to dripping or splashing and no objects filled with liquids, such as vases, shall be placed on the apparatus.**



**TO PREVENT ELECTRIC SHOCK DO NOT REMOVE THE COVER. THERE ARE NO USER SERVICEABLE PARTS INSIDE. REFER SERVICING TO QUALIFIED PERSONNEL**

## Introduction

The MLD9 Induction loop driver has been designed as a high quality dual channel amplifier for use with multiple loop or Phased Array loop designs.

An Array System provides a solution where a simple loop around the room perimeter will not work. Arrays are the standard solution for buildings with metal structure or reinforcements, or for covering large areas. Arrays can also dramatically decrease the 'spill' of the magnetic signal outside of the room, allowing induction loops to be installed in adjacent rooms, and providing an improved level of confidentiality. Arrays can also be used to change the way two loops interfere with each other, providing ways of solving even the most complex installation problems.

Depending on a number of factors regarding the installation of the loop and the set-up of the amplifier the MLD9 can provide compliance with IEC60118-4 for perimeter loop areas of up to 2 x 1,300m<sup>2</sup> or phased array systems upto 3,300m<sup>2</sup>.

Ease of installation and use have been major factors in the design, combined with optimised performance, and the freedom from R.F.I. generation.

The MLD9s two output channels can be configured with or without 90° of phase shift between the two, allowing the use of array systems or two separate loops with the same signal therefore doubling the area coverage.

The MLD9 has two balanced inputs. These can be configured for microphone or line inputs with individually selectable phantom and gain boost.

For more complex installations, you may need ancillary equipment such as microphone pre-amplifier(s), adaptor(s) for use with 100V line, or signal processing units. See Accessories or contact Ampetronic for advice.

## QUICK START

For those who have a good appreciation of loop systems, the following is a very quick guide to setting up the amplifier: All you need is an ac power source, a signal source and a Phased Array loop pair. See 'Designing Induction Loops' handbook (supplied) or contact Ampetronic for advice.

### Installation

- a. Turn all controls fully anti-clockwise.
- b. Connect loop cables.
- c. Connect signal input(s).
- d. Connect power. See points 6 and 7 in SAFETY section.
- e. If rack mounted remove all rubber feet from units. DO NOT re-fit the feet fixing screws as this may cause damage and invalidate the warranty

### Operation

1. Switch ON – check 'ear symbol' flashes during self test and illuminates continuously when checks are complete.
2. Apply input signal and increase the input control until two green COMPRESSION LEDs are illuminated on the peaks of the signal.
3. Select phase shift required 0 or 90°.
4. Adjust the CURRENT controls until the CURRENT LEDs illuminate to achieve the desired peak currents.
5. Repeat step 2 for any other inputs used.
6. Listen to the magnetic field produced inside the loop area using a receiving device (e.g. Ampetronic ILR3), or examine the performance in more detail with a field strength meter.
7. Adjust MLC control to achieve a flat frequency response.

# CONNECTIONS

## Inputs

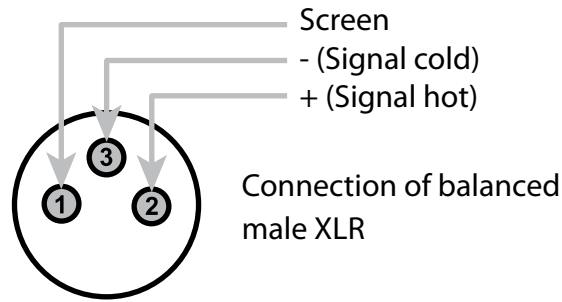

## Outputs

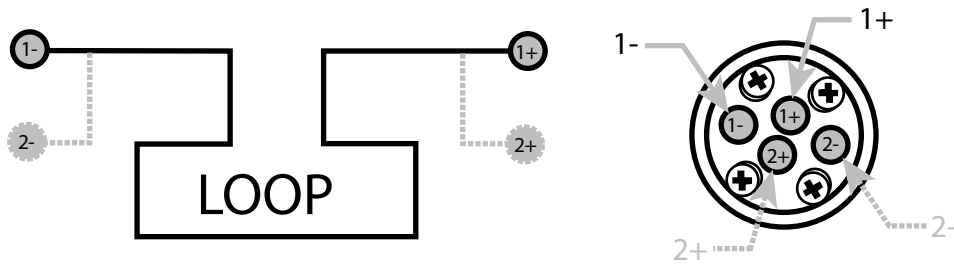
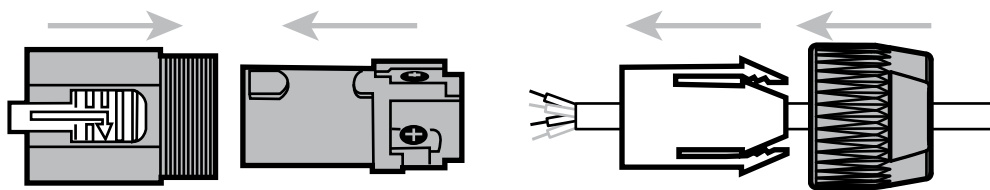

1 = Twisted Pair, 2 = Quad Core

Refer to technical specifications for connection details

# BLOCK DIAGRAM

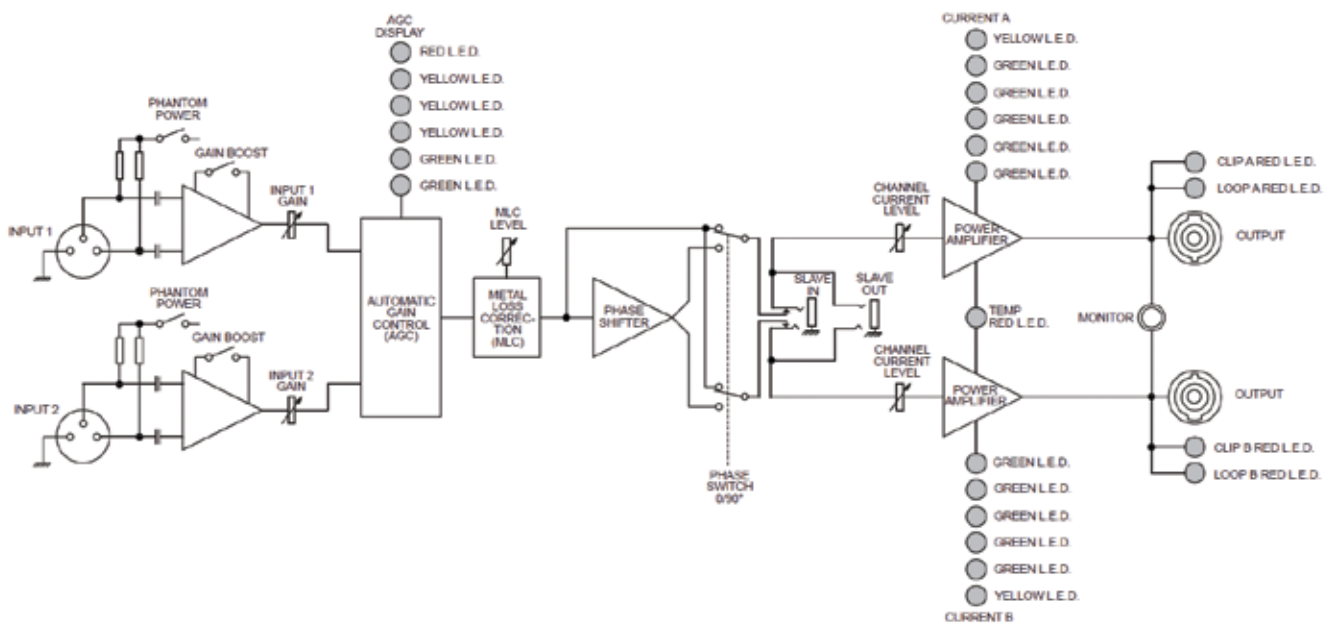

# INSTALLATION

## Location

The unit may be free standing or 19" rack mountable using the rack 'ears' supplied. Fitting of the 'ears' is achieved by removing the three forward most screws on both sides. The same screws are then re-used to secure the 'ears' in place. (A PH2 screwdriver will be required). For 19" rack mounting the four rubber feet must be removed.



The location must provide adequate ventilation for the unit.

Internal fans provide forced ventilation using air vents at the front (intake) and rear (exhaust) of the unit. These vents must be unobstructed for satisfactory cooling. If the unit is installed in an enclosed environment, sufficient airflow into the enclosure must be provided through vents, fans or other means, such that the units exhaust air is not recycled to the inlet - causing a reduction in output current or OVERHEAT LED to be illuminated.

Contact Ampetronic for advice on cooling requirements for your installation.

## Tools and Equipment

Small hand tools including a wire stripper and a small flat blade screwdriver will be required.

An ILR3 loop receiver or a magnetic field strength meter is vital to check that the loop system is providing the desired level of performance.

A pair of stereo headphones with a 3.5mm jack plug connection is also useful to monitor the loop signal.

## System Requirements

The induction loop cables should be already installed according to the 'Designing Induction Loops' handbook, or as per specific design instructions provided by Ampetronic. As a result, a target current should be known, based on achieving acceptable field strength across the area to be covered.

In order to achieve correct operation it is recommended the loop and feed resistance should be between 0.5 and 3Ω (at DC). Values outside this may cause the LOOP ERROR LED to illuminate and the amplifiers output to be disabled. Loop and feed impedance (at 1.6KHz) should be less than the voltage capability of the driver divided by the target current required to achieve field strength. Values above this figure may cause the CLIP LED to illuminate. See troubleshooting section for advice on how to correct this and get your system working.

The 'Designing Induction Loops' handbook contains more details on loop and feed cables. The correct design and positioning of the actual loop is vital for satisfactory system performance. If in doubt consult Ampetronic for advice.

# CONNECTION & SET-UP

It is advised that the loop system is initially set up using a local audio source such as a CD player, which is not connected into any other system. This avoids the complication of ground loops and feedback etc, whilst the unit is set up.

The following procedure describes the installation of a stand-alone MLD9, and does not incorporate connection of other ancillary units such as microphone pre-amps, mixing desks, or signal processing units.

1. Turn all controls fully anti-clockwise.
2. Connect the feed cables from the loops into the NL4 loop connectors supplied as shown:

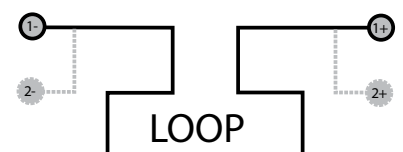

*Note: To avoid unwanted stray magnetic fields the feed cable should be tightly twisted or star-quad connected.*

3. Connect the signal inputs appropriately:

Microphones: Suitable dynamic or condenser microphone with balanced cable feed. Select phantom power as required. Connect to INPUT 1 and INPUT 2 (with selector switches in the appropriate position) using a 3-pole XLR plug wired as per Connections drawing.

Line level signals: From other audio equipment such as PA system, mixing desk or CD player. Connect to INPUT 1 and INPUT 2 (with selector switches in the appropriate position) using a 3-pole XLR plug wired as per Connections drawing. You may use either or both inputs.



Do not run input and output cables close together

4. Connect AC power to the MLD9. See points 6 and 7 in Safety section.

5. Switch ON. The 'ear' symbol will flash for a few seconds whilst an internal self-test is performed and the loop resistance is tested. If both tests are successful, the 'ear' symbol will illuminate continuously and the unit will be in an operational mode. If the 'ear' symbol continues to flash, or one or both LOOP LEDs illuminate, consult the Troubleshooting section.

6. Select one input and apply a suitable audio signal (ideally a CD player with music or continuous speech applied to one input, with no connection to the other). Turn the associated input control clockwise until two COMPRESSION LEDs are illuminated on the peaks of the signal.

7. Turn CH A CURRENT control clockwise until the target current is achieved – as indicated by the CH A CURRENT LEDs. Note that consecutive LEDs illuminate at 3dB intervals. Turn CH B CURRENT control clockwise until the target current is achieved – as indicated by the CH B CURRENT LEDs. Headphones can be used with the MONITOR socket to listen directly to the loop current. NOTE: channel A output appears in the left headphone and channel B in the right. If high frequency oscillation or low frequency hum is experienced, consult the Troubleshooting section.

8. The loop system should now be providing a magnetic field inside the area of the loop – use the ILR3 or field strength meter to examine its performance with respect to:

- a) Magnetic field strength. This may vary across the coverage due to layout, metal loss and loop current.
- b) Frequency response. Metal losses tend to increase with frequency, and may require the adjustment of the MLC control.

As a result of this analysis, adjust the CURRENT and set the MLC to achieve the best sound quality. This should result in adequate magnetic field strength and a level frequency response in order to satisfy IEC60118-4. Note: Do NOT adjust the MLC control whilst listening to the MONITOR socket as this will not give a true indication of the response of the actual loop.

Once the CURRENT and MLC controls have been adjusted to the correct level they should NOT need re-adjusting.

9. If not already done so, steps can now be taken to integrate the MLD9 into a PA / mixer arrangement following standard audio techniques. If any unusual effects are experienced refer to the Troubleshooting section.

*Note: Ideally, each input signal level should be set up to achieve 6dB (one LED) of COMPRESSION with the quietest level of input likely to be used. This will maximize the dynamic range of the system and ensure satisfactory performance.*

10. Repeat the above procedure for each input used. When adjusting each input, make sure the signals are removed from the other inputs. This ensures that all signals are set to equivalent loudness and drive the compressor properly.

# OVERVIEW

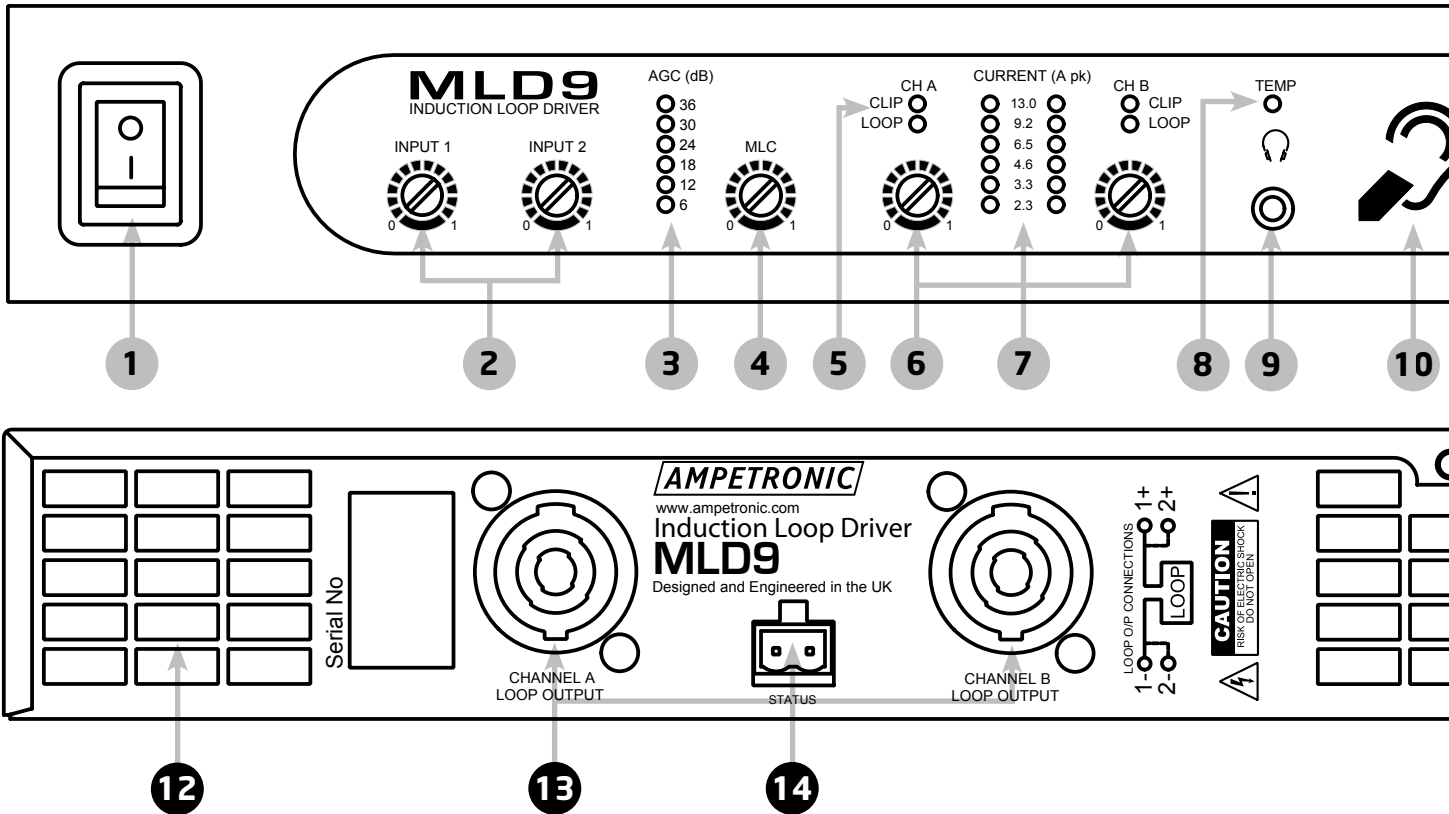

- 1 I/O: Power Switch.
- 2 INPUT 1 & 2: Screwdriver adjustable controls which set the level of the input signals.
- 3 **AUTOMATIC GAIN CONTROL (AGC) COMPRESSION:** Shows the amount of gain reduction in decibels (dB) that is applied to the input signal(s).
- 4 **METAL LOSS CORRECTOR (MLC):** Screwdriver adjustable control which compensates for the frequency dependant effects of metal in the looped environment.
- 5 **OUTPUT CHANNEL WARNING LEDs:** 'CLIP' LED signifies output voltage is clipping, 'LOOP' LED signifies a cable specification error or damage. See troubleshooting for details.
- 6 **OUTPUT CHANNEL CURRENT ADJUSTMENT:** Screwdriver adjustable control which sets the level of output current delivered to the loop.
- 7 **OUTPUT CHANNEL CURRENT LEDs:** Indicates the peak current delivered to the loop.
- 8 **TEMPERATURE WARNING LED:** Indicates that the internal heatsink is too hot. Loop current is not delivered to either channel. See troubleshooting for details.
- 9 **MONITOR:** 3.5mm jack socket for use with stereo headphones to listen to the signal being delivered to the loop.
- 10 **POWER INDICATOR LIGHT:** Flashes continuously when amplifier has failed self test and is in safe mode. See troubleshooting for details.
- 11 **FRONT VENT:** Fan assisted ventilation inlet with filter. DO NOT cover.



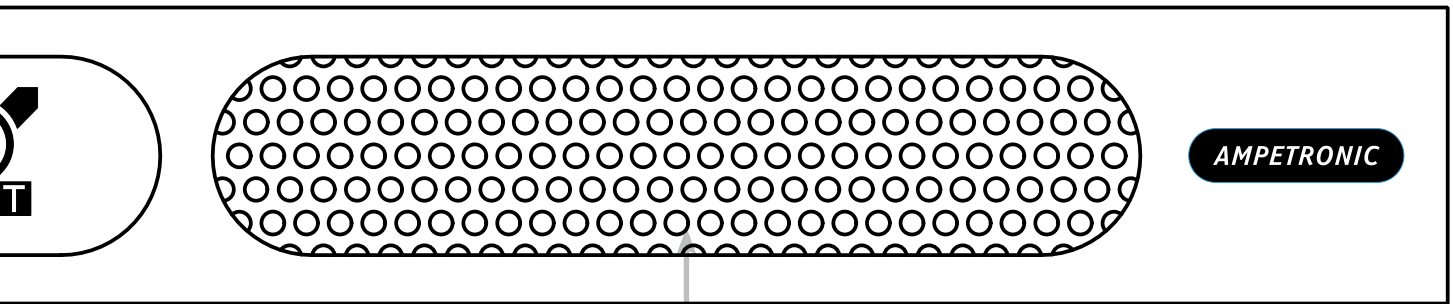

11

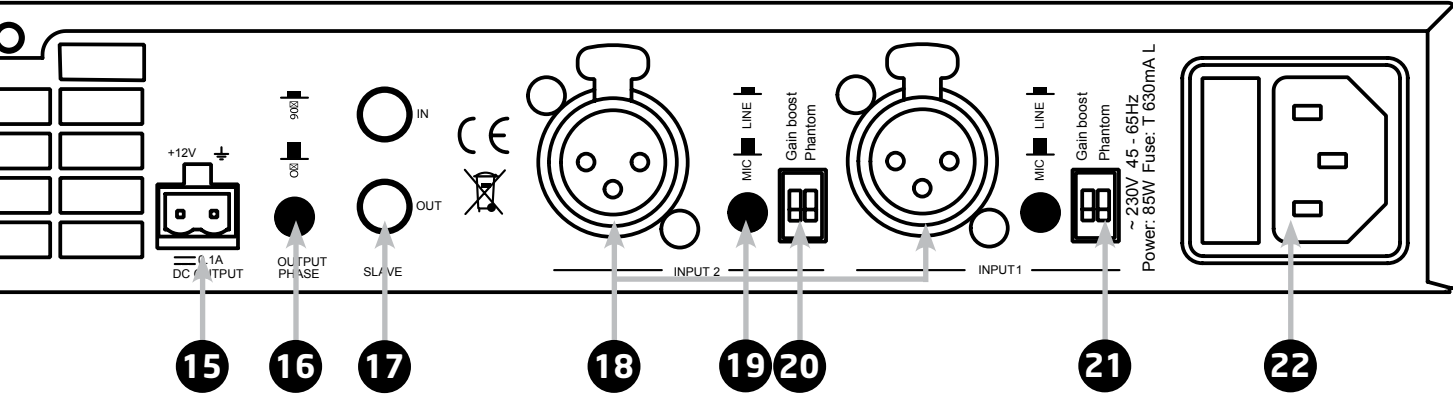

- 12 **REAR VENT:** Fan assisted ventilation outlet. DO NOT cover.
- 13 **LOOP OUTPUT(S):** Neutrik 'Speakon' high current connections to loop cable(s).
- 14 **STATUS:** Connection to relay contacts providing remote fault indication.
- 15 **DC OUTPUT:** 2-pin connection for ancillary units.
- 16 **PHASE SHIFT SELECTOR:** Selectable 90° phase shift between outputs.
- 17 **SLAVE I/O:** 3 pole 6.4mm jack insert point for use with ancillaries
- 18 **XLR INPUTS:** Socket for balanced MIC or LINE signals.
- 19 **INPUT SELECTOR SWITCH:** Mode select between MIC and LINE input signals.
- 20 **INPUT GAIN BOOST SELECTOR SWITCH:** Gain selector (ON = +15dB)
- 21 **INPUT PHANTOM POWER SELECTOR SWITCH**
- 22 **AC POWER:** Standard 3-pole IEC320 connector containing primary fuse for the unit.

## TROUBLESHOOTING

### Ear symbol not illuminated

- Check that the power switch is toggled to the ON (I) position.
- Check fuse continuity. A 20mm fuse is incorporated into the AC POWER inlet. It is necessary to remove the power cord before extracting the fuse holder. Test the continuity of the fuse using a multimeter. A spare fuse is provided in the fuse holder.



Any replacement fuse **MUST** be of the same rating and type as printed on the rear of the unit.

### Ear symbol flashing continuously

Amplifier has failed self test and is in safe mode. Signal will not be fed into one or both loops. Switch the unit off, remove all connections except the loop and power connections, turn all front panel controls to minimum and switch back on. If the problem persists, contact Ampetronic for advice.

### COMPRESSION LEDs not illuminating

Check input connections.

Ensure that the appropriate front panel control (INPUT1 or INPUT2) is turned up. Check there is sufficient signal level for the required input.

### CURRENT LEDs not illuminating

There are many possible causes for this:

- Check the COMPRESSION LEDs are illuminating.
- Check that the CURRENT controls are turned up sufficiently.
- Check the LOOP, or TEMP LEDs are not illuminated.
- Ensure the Ear symbol is illuminated and not flashing.
- Check that the loop cables are connected, terminated correctly and inserted into the LOOP OUTPUT sockets.
- Check the loops are not open circuit, short circuit, or connected to earth (see instability or high frequency noise section of Troubleshooting)
- Switch the unit off and turn back on.

*Note: You can listen to the actual loop signal by using a pair of headphones plugged into the monitor socket. Channel A = left, channel B = right.*

### CLIP LED(s) illuminated

Indicates that the output voltage is clipping. Occasional lighting of this indicator is normal on peaks of signal.

- Turn down the CURRENT control on the channel(s) in question to avoid causing the output voltage to clip.
- Check the loop is not open circuit, short circuit, or connected to earth (see instability or high frequency noise section of Troubleshooting)
- Check the loop is within specified limits.

### TEMP LED illuminated

Indicates that the internal heatsink is too hot. Loop current is not delivered to either channel.

- Ensure that the unit is installed in a location with sufficient ventilation

- Check that nothing is blocking the free flow of air through the vents at the front and back of the unit.
- Check the loops are not open circuit, short circuit, or connected to earth (see instability or high frequency noise section of Troubleshooting)

### **LOOP LED(s) illuminated**

Indicates the loop cables connected to the unit are outside the loop resistance test limits (see technical specifications). If these values are exceeded the LOOP LED(s) will illuminate and the amplifier output(s) will be disabled.

*Important: Once the cause of any loop error has been established the unit will need to be restarted. Turn the power OFF - wait 5 seconds, and switch ON.*

- Check that the loop cables are connected, terminated correctly and inserted into the LOOP OUTPUT sockets. Restart the amplifier as above.
- Ensure the DC resistance is between the upper and lower loop resistance test limits (see technical specifications).

*Note: Meter leads can easily measure 0.2Ω, and should be factored out.*

- If either loop is open circuit - it may have been cut somewhere and will require investigation and potentially re-laying.
- If either loop is high resistance >5Ω - check all connections and re-tighten, there may be something loose.
- Check for short circuits in the loop connectors.
- If either loop has very low resistance, use an appropriate length of cable to ensure the loop resistance is greater than the lower loop resistance test limit (see technical specifications).

*Note: High or low resistance loops can be encountered in a venue with a pre-installed loop, which was designed for use with an old loop driver which might be being replaced. Before using this loop ensure that the existing loop will allow the system to perform to an acceptable level by checking it's layout details in the 'Designing Induction loops' handbook.*

### **Low magnetic field strength**

Due to insufficient CURRENT or excessive metal loss.

May require a special loop design to achieve acceptable performance, contact Ampetronic for advice.

### **Instability or high frequency noise**

1. It is possible for the loop cables to be grounded under fault conditions, resulting in instability which may sound like high frequency noise, buzz or whistling. The results of this type of fault are unpredictable and may appear as any combination of the front panel indication errors
2. This fault is easy to determine. Simply unplug the loop cables from the amplifier and test with a resistance meter between either of the loop wires and a good earth point such as a metal radiator. There should be an infinitely high reading i.e. no connection at all. Any reading indicates a failure of the loop cable insulation and you will need to either repair or replace the loop cable.
3. Instability can be caused by using poor quality signal cables, long unbalanced (2-wire) signal runs to the inputs, or by running input cables in close proximity with the loop wire over an appreciable distance. Loop amplifiers are capable of delivering high currents at audio frequencies. If the loop cables are run close to sensitive signal cables it may be possible to induce a signal back into the input of the amplifier causing feedback. Cable runs and loop

wires should be kept well apart from each other. To avoid interference maintain a separation of at least 300mm.

4. Instability can cause the amplifier to run hot and may result in the TEMP LED illuminating.

## **Interference**

1. Background magnetic field signals or interference may be present in any location and may not be anything to do with the loop system. Monitor this with a loop receiver (such as an ILR3). If the interference is still present with the loop system switched off, then you need to locate and eliminate the source of the interference before switching the loop system back on
2. Magnetic fields can induce currents into any low impedance electrical path or loop. Audio or video systems with multiple earths may experience pick up of the loop signal. Check entire sound system for evidence of loop signal, and trace source of pick up.
3. Under certain circumstances, the loop signal may appear as jagged lines or hum bars on a CCTV picture. This could be due to running CCTV (low impedance unbalanced 2-wire circuit) cables in close proximity to the loop cable. Separate the loop cables to reduce the effect.
4. Remote (and apparently unconnected) PA systems can sometimes pick up loop signals. This is usually because the loop cable becomes damaged (see point 1 of Instability) or induces signals into the remote system through long unbalanced cables. Always run long audio signal cables as 3-wire balanced circuits and keep away from loop cables.
5. See also point 1 of Instability

## **Failed AC power fuse in rear of unit**

Unplug the loop and AC power supply from amplifier, and replace the failed fuse with the spare fuse in AC power input fuse tray.

Reconnect the AC power supply and switch on. If the fuse fails again, return the unit to Ampetronic for evaluation - it may well be covered under warranty, which will be invalidated by removing the cover. If the fuse does not fail a 'loop error' may be indicated, but shows that the unit is working correctly. Re-connect the loop and switch the power off then on again to reset loop error.

If the fuse fails when the loop is re-connected to the unit, then the loop could be shorted to electrical mains (and building) earth. This can happen even if no audio signal is present, as the short to earth is likely to cause an instability / oscillation / feedback condition to develop. A loop cable short to earth most commonly occurs where flat copper tape is installed on a metal-clad raised access flooring system. If the insulation on the flat copper tape is abraded (for example by a piece of metal swarf trapped below the copper tape), the conductor could short to the earthed tiles.

When installing on raised access floors, it is advisable to insulate beneath the flat copper tape installation using Ampetronic PWT or similar tape.

The loop short to earth may only be completed when a person steps on the tape in the affected location, which can create significant difficulties when diagnosing the cause of fuse failure. Contact Ampetronic for further advice if a unit is suffering recurring but untraceable failure of the rear panel fuse.

## **ACCESSORIES**

Details of all products and services provided by Ampetronic can be found at [www.ampetronic.co](http://www.ampetronic.co)

# Technical Specifications

INPUTS AND PROCESSING	MIC		Line		UNITS
Input figures quoted at maximum front panel gain control setting.	Low gain	High gain	Low gain	High gain	
<b>INPUTS;</b> XLR connector. Balanced, Suitable for up to 600Ω microphones or line level. Input impedance Sensitivity Overload Phantom (via 680Ω source)	8700 -62 -24 12	8700 -77 -39 12	8700 -37 +1 -	8700 -52 -14 -	Ω dBu dBu Vdc
<b>AGC;</b> Compression of signal in dB shown on six front panel LEDs Input range Output range Min. input level for AGC Attack time Decay time	>36 ±1 Depends on input mode used (see sensitivity) 8 2				dB dB ms s
<b>METAL LOSS CORRECTION;</b> Specially designed adjustable filter to compensate for the effects of metal loss. Gain @ 1kHz remains constant Min. slope Max. slope	0 +3				dB/oct. dB/oct.
<b>PHASE SHIFT;</b> The loop outputs can be configured for phased array systems by selecting the appropriate rear panel switch option. Phase shift between outputs: Phase shift off Phase shift on	0 90				° °
<b>OUTPUTS</b> <b>SLAVE IN;</b> 6.35mm jack. Input for linking more than one amplifier. Inserting plug disables other inputs. Input impedance / channel Input level / channel	MLD5	MLD7	MLD9	UNITS	
	N/A N/A	N/A N/A	<b>100</b> <b>1.5</b>	kΩ Vpk	
<b>OUTPUTS</b>	MLD5	MLD7	MLD9	UNITS	
<b>SLAVE OUT;</b> Processed audio signal output. Post AGC, MLC and Phase shift. For linking to another amplifier. Source impedance / channel Output level / channel	N/A N/A	N/A N/A	<b>220</b> <b>1.5</b>	Ω Vpk	
<b>LOOP OUTPUT;</b> (per channel); NL4 speakon. 1 per channel. Voltage peak/RMS Current peak/RMS into single turn loop. Absolute maximum short term peak current. THD +N (@1kHz full output) Output impedance Frequency response (±1.5dB no AGC) Output current indicated via six front panel LEDs (per channel) at 3 dB intervals. Bipolar PPM style circuit Attack decay	14.5 / 10 7 / 5 >10 <0.2 22 100 to 5000 4.7 1	24 / 17 9 / 6.4 >13 <0.2 22 100 to 5000 4.7 1	45 / 32 13 / 9.2 >19 <0.2 24 100 to 5000 4.7 1	V A A % Ω Hz ms s	
<b>STATUS SOCKET;</b> 2 pin 5mm pitch 90° header. The status socket consists of a pair of isolated contacts. Amplifier or load fault Amplifier and load OK Contact rating Dielectric strength (coil – contact)	Open Closed DC 2A, 28V, 60W AC 0.5A, 125V, 60VA 1000Vac 50/60Hz				
<b>DC POWER SOCKET;</b> 2 pin 5mm pitch 90° header. The DC POWER socket is used to power a variety of Ampetronic accessories. Output voltage Output current (max.)	12 0.1	12 0.1	12 0.1	V A	
<b>PROTECTION FEATURES</b>	MLD5	MLD7	MLD9	UNITS	
<b>CLIPPING;</b> Clipping of either output is shown on the front panel CLIP LEDs. If clipping persists amplifier will shutdown and restart. Clip threshold (% of peak output voltage)	93	93	93	%	
<b>OUTPUT DC OFFSET;</b> If DC offset is detected amplifier will shutdown and restart Threshold	±0.7	±0.7	±0.7	Vdc	
<b>TEMPERATURE;</b> Internal heatsinks are monitored. If temperature reaches set limits the output current is reduced and eventually muted. MLD9 & 9 have separate independent systems for each channel, MLD9 has a single control for both channels. Output current reduction (3dB max) Output mute (illuminates TEMP LED) <i>Any of the above faults also cause the status relay contacts to open.</i>	Commences 88, max @ 92 92 (output returns at approx. 60)				°C °C
<b>LOOP RESISTANCE TESTING;</b> Checks the resistance of the load on startup (The POWER LED flashes during this period) and only allows operation if within limits. The LOOP LEDs are illuminated if loads are outside limits Startup time Lower limit Upper limit Upper limit (link removed)	8 approx. 0.3 5 No limit	8 approx. 0.3 5 No limit	8 approx. 0.5 5 No limit	s Ω Ω	

PROTECTION FEATURES CONTINUED	MLD5	MLD7	MLD9	UNITS
<b>CURRENT LIMIT;</b>	15	22	22	Apk
<b>COOLING;</b> internal variable speed fan(s). Intake on front, exhaust on rear panel No. of fans Fan noise (@1m no load) Fan noise (@1m EN600625 test signal max rated current)	1 33 <47	2 33 <47	2 33 <47	 dBA dBA
POWER REQUIREMENTS & PHYSICAL	MLD5	MLD7	MLD9	UNITS
<b>Standard IEC inlet</b> Mains supply voltage Frequency	230 (115) 45-65	230 (115) 45-65	230 (115) 45-65	Vac Hz
<b>Power</b> (EN60065 test signal max rated current)	80	160	220	W
<b>Fuse</b>	T 630mA L (T 1.25A L)	T 1.6A L (T 3.15A L)	T 2.5A L (T 5A L)	A
<b>Inrush Current</b>	16	27	40	Apk
<b>Weight</b>	3.75	4.77	6.35	Kg
<b>Dimensions;</b> Width Height Depth	430 44 220	430 44 250	430 44 330	mm mm mm
<b>ENVIRONMENTAL;</b> Ingress Protection Operating temperature range Relative humidity	IP20 0-35 20-90	IP20 0-35 20-90	IP20 0-35 20-90	 °C %

## WARRANTY

This product carries a five year parts and labour warranty from date of shipment from Ampetronic. To qualify for the five year warranty, the product must be registered at [www.ampetronic.co](http://www.ampetronic.co) (products/warranty), without which the warranty will be valid for two years only.

The warranty could be invalidated if the instructions in this handbook are not followed correctly, or if the unit is misused in any way.

## DECLARATION OF CONFORMITY

Manufacturer: Ampetronic Ltd.  
Unit 2, Trentside Business Village, Farndon Road, Newark, Nottinghamshire,  
NG24 4XB, United Kingdom.

Declares that the product:

Description: Induction Loop Driver  
Type name: MLD9

Conforms to the following Directive(s) and Norm(s):

Directive 2004/108/EC  
EMC: EN55103-1 : 2009 Emission  
EN55103-2 : 2009 Immunity  
Directive 2006/95/EC  
Safety: EN60065 : 2002+A12:2011  
Directive 2011/65/EU RoHS

Date: May 2013

J.R. Pieters  
Managing Director,  
Ampetronic Ltd.

# INSTALLATION NOTES:

.....

.....

.....

.....

.....

.....

.....

.....

.....

.....

.....

.....

.....

.....

.....

.....

.....

.....

.....

.....

.....

.....

.....

